

TV Magic Box User Manual



Version	Date	Author	Description
v0.1	3/12/2026	Tide	Initial version
v0.2	3/20/2026	Tide	Add HDMI0 AT info
v0.3	4/12/2026	Tide	Fine tune document

Author:	Tide Yin
Doc Type:	Public
Date:	4/12/2026
Version:	v0.3
Hardware:	v2
Relative Doc	N/A

Contents

Chapter 1: TV Magic Box information	1
1.1 Introduction	1
1.2 Features	2
1.3 Block diagram	4
Chapter 2: TV Magic Box's Ports	5
2.1 Port Overview	5
2.2 IR/Key and TV LED Port	5
2.3 Speaker Sampling Port	6
2.4 HDMI Ports	6
2.5 Host USB & USB HUB	8
2.6 TV USB	8
2.7 12V power input port	9
2.8 TV power output port	9
Chapter 3: HDMI port test / Debug and Unbrick	10
3.1 HDMI1 Group	10
3.2 HDMI2 Group	11
Chapter 4: TV USB port test and extension test features for TV test	12
4.1 USB Switch	12
4.2 Onboard UDisk	12
Chapter 5: IR/Key Emulation and LED monitor	13
Chapter 6: Display Adaptor Board Configuration/Control and Video/Audio combination .	14
Chapter 7: TV mainboard power switch and monitor	15
Chapter 8: TV Magic Box status monitor	16
8.1 LCD	16
8.2 Front panel Green LED	16
8.3 Front panel 2 Color LED	17
8.4 Front panel 3 Color LED	17
8.5 Front panel Button	17
8.6 Side LEDs of HDMI ports	17
8.7 Side LEDs of TV USB switchers	18
Chapter 9: TV Magic Box Host Tools	18
9.1 Downloading tool	18
9.2 Configuration tool	18
9.3 Engineering tool	18
Chapter 10: System AT Command	18
10.1 Common System SW Command	18
10.2 Specific SW Command	19
10.3 Common System HW Command	20

Chapter 1: TV Magic Box information



1.1 Introduction

TV Magic Box is a testing box which is generally used to test TV mainboard. The testing experience is similar to testing with a TV set. And TV Magic Box integrated some debug assistant features, by using TV Magic Box that user does not need some test accessories he used before, such as debug cable, UDisk etc. And TV Magic Box can be flexibly configured by AT commands to support variant TV products with different SoC platform/display mode/debug config etc. TV Magic Box was designed for test automation, it can promote automation ratio from 70% up to almost 100% with test automation framework in host side which contains mature test architecture with CV/AI features.

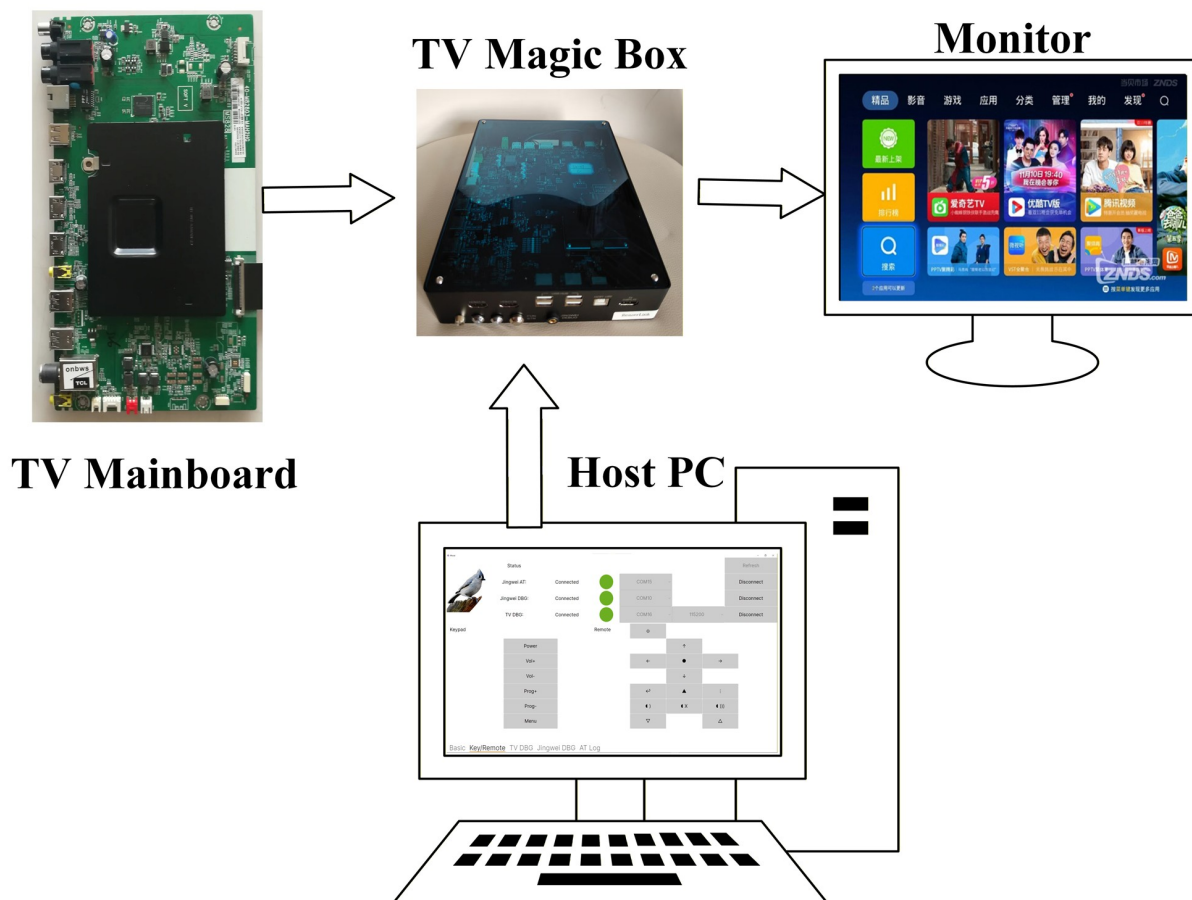

1.2 Features

1.2.1 TV debug port support

Per hardware design TV Debug UART goes through HDMI. But different products define different HDMI pins and enable signals for Debug UART port. TV Magic Box build in debug cable on TV Magic Box PCBA which can use AT command to config right pins and enable signals for Debug UART port. Picture below shows pin and control signals through HDMI definition of some of our projects.

Disable All pins	TMD5261 Port : P2 Normal HDMI	Debug: HDMI2 HDMI_5V, 5V	Debug: HDMI2 UART_EN, 5V	Debug: HDMI2 HDMI_DEBUG_9V HDMI_UART_EN, 9V	Debug: HDMI2 HDMI_DEBUG, -9	Debug: HDMI2 From 2/14 pin	Unbrick: HDMI1 HDMI1 for unbrick
Case 0	Case 1	Case 2	Case 3	Case 4	Case 5	Case 6	Case 9
Data2_P	Data2_P	Data2_P	Data2_P	Data2_P	Data2_P	Data2_P	Data2_P
NC	UART_RX	NC	NC	NC	NC	UART_RX	NC
Data2_N	Data2_N	Data2_N	Data2_N	Data2_N	Data2_N	Data2_N	Data2_N
Data1_P	Data1_P	Data1_P	Data1_P	Data1_P	Data1_P	Data1_P	Data1_P
GND	Data1_S	GND	GND	GND	GND	GND	GND
Data1_N	Data1_N	Data1_N	Data1_N	Data1_N	Data1_N	Data1_N	Data1_N
Data0_P	Data0_P	Data0_P	Data0_P	Data0_P	Data0_P	Data0_P	Data0_P
GND	Data0_S	GND	GND	GND	GND	GND	GND
Data0_N	Data0_N	Data0_N	Data0_N	Data0_N	Data0_N	Data0_N	Data0_N
Clock_P	Clock_P	Clock_P	Clock_P	Clock_P	Clock_P	Clock_P	Clock_P
GND	Clock_S	GND	GND	GND	GND	GND	GND
Clock_N	Clock_N	Clock_N	Clock_N	Clock_N	Clock_N	Clock_N	Clock_N
CEC	CEC	CEC	CEC	CEC	CEC	CEC	CEC
NC	UART_TXD	NC	UART_EN	HDMI2_DEBUG	HDMI2_DEBUG	UART_TXD	NC
I2C_SCL	I2C_SCL	I2C_SCL/UART_RX	I2C_SCL/UART_RX	I2C_SCL/UART_RX	I2C_SCL/UART_RX	I2C_SCL	I2C_SCL
I2C_SDA	I2C_SDA	I2C_SDA/UART_TX	I2C_SDA/UART_TX	I2C_SDA/UART_TX	I2C_SDA/UART_TX	I2C_SDA	I2C_SDA
GND	DDC_CEC_GND	GND	GND	GND	GND	GND	GND
5V_PWR	5V_PWR	5V_PWR (Y->I2C, N->UART)	5V_PWR	5V_PWR	5V_PWR	5V_PWR	5V_PWR
HDMI_HPD=L	HDMI_HPD=HDMI_HPD_SINK	HDMI_HPD=L	HDMI_HPD=L	HDMI_HPD=L	HDMI_HPD=L	HDMI_HPD=HDMI_HPD_SINK	HDMI_HPD=L

1.2.2 LVDS and VB1 convert to HDMI output

Different TV products are using HD LVDS/FHD LVDS/UHD VB1@*4K*60Hz/UHD VB1@4K*120Hz panel etc. with different display parameters. TV Magic Box can convert all the signal types with right parameters to 1080P HDMI output by using AT command to initial display adapter board inside TV Magic Box box.

1.2.3 TV PCBA Speaker audio addon to HDMI output

To provide friendly user experience of testing TV mainboard as TV set. TV Magic Box samples TV mainboard's speaker analog signal to I2S Digital signal and combine it with display video signal into 1080P HDMI output.

1.2.4 Power Key and Function Keys emulation

There's a power key/function keys daughter board to provide key value to mainboard. The daughter board cross products working method is same. TV Magic Box use the method to issue key values from TV Magic Box triggered by AT commands.

1.2.5 IR signal emulation

There's a IR signal daughter board to receive IR code from and transfer to mainboard. The daughter board cross products working method is same. TV Magic Box omit IR receiver part and emulate IR signal from TV Magic Box triggered by AT commands.

1.2.6 TV LED monitor

There's a TV LED daughter board which contains LED to show TV's working state. TV mainboard transfer GPIO control to LEDs on the board. TV Magic Box contains same LEDs and can monitor the LEDs' status by using TV Magic Box SoC's GPIO input.

1.2.7 PCBA power switch and monitor

For some special cases , tester need cut mainboard's power to do cold reboot and need monitor mainboard's power consumption. TV Magic Box provides the capabilities which can be controlled by AT commands.

1.2.8 TV HDMI input signal switch

To emulate physical HDMI cable plug in/out. TV Magic Box integrated high speed HDMI switchers which can be controlled by AT commands to switch HDMI on/off.

1.2.9 TV USB port signal switch

To emulate physical USB cable plug in/out. TV Magic Box integrated high speed USB switchers which can be controlled by AT commands to switch USB paths and switch USB on/off. There are three valid USB paths in TV Magic Box: Host to DUT/Host to UDisk/DUT to UDisk.

1.2.10 Onboard UDisk

There's an onboard UDisk. The UDisk can be used for TV USB testing and TV image upgrading by switching USB path.

1.2.11 TV Unlock support

TV Magic Box can support unlock TV unit by using right commands go through HDMI UART and USB.

1.2.12 TV Unbrick support

TV Magic Box can support unbrick TV unit by using right commands go through HDMI UART and USB.

1.3 Block diagram

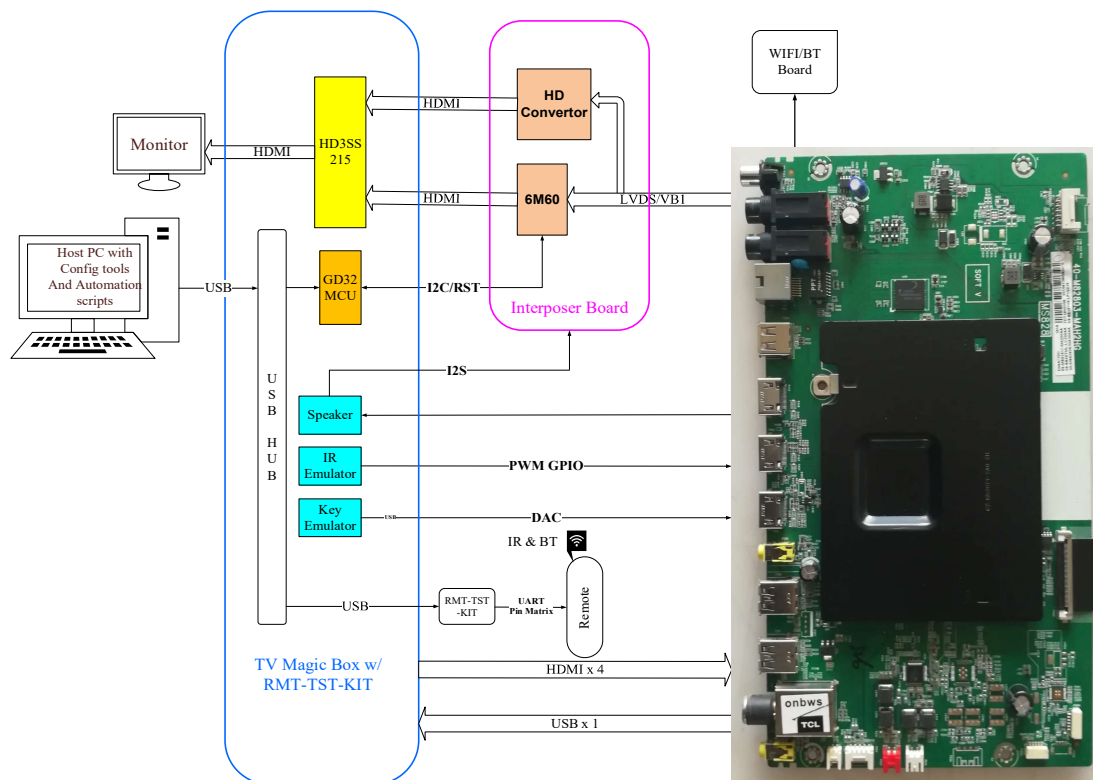

Chapter 2: TV Magic Box's Ports

2.1 Port Overview

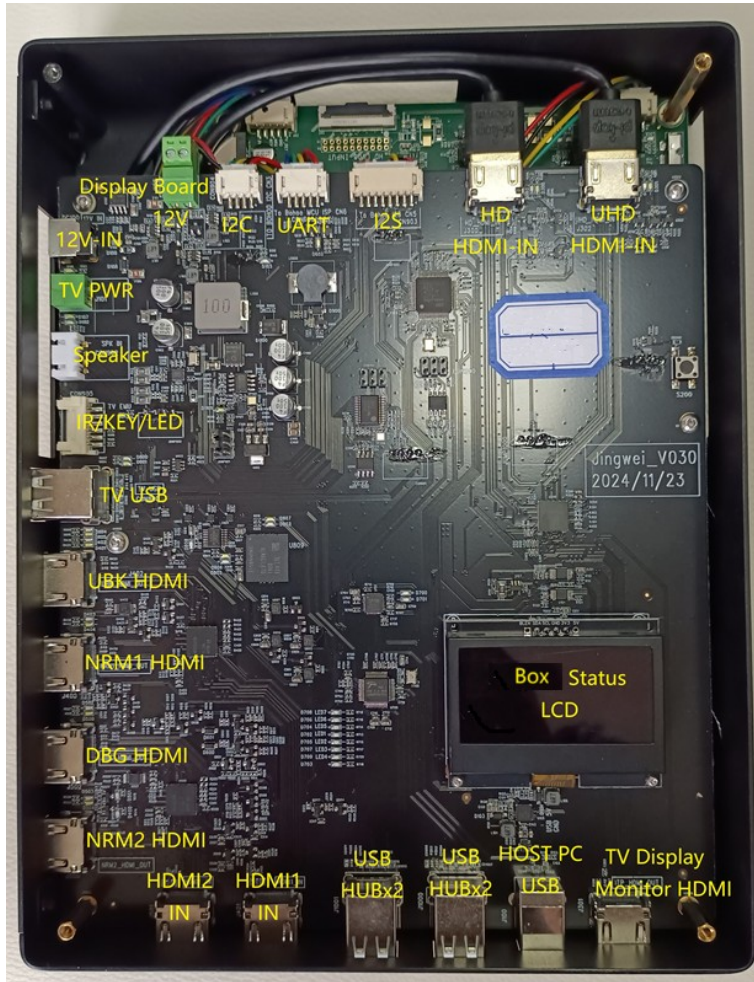

2.2 IR/Key and TV LED Port

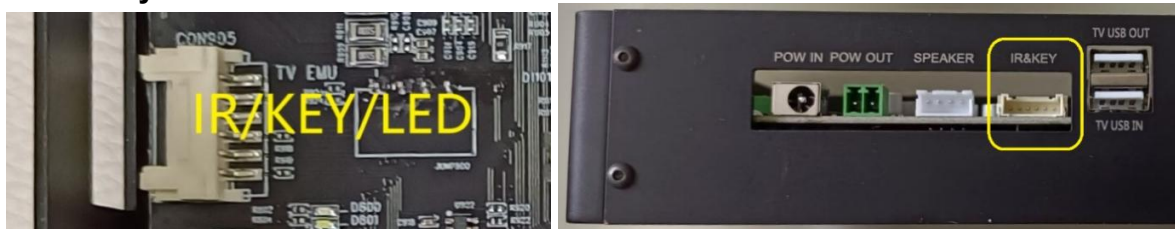

TV connects its IR/Key and TV LED connector with this connector instead of connect with real IR/Key/LED daughter board. Customized cable is needed since different TV product has different IR/Key/LED connector. Connector at TV Magic Box side is common. There's a connector on TV mainboard which connect with a function daughter board to get Key/IR signals and send LED signals to the LED board. TV Magic Box can emulate Key/IR signals

and monitor LED status from TV mainboard. the IR/Key/LED port connect with this port of TV mainboard to support the function.

2.3 Speaker Sampling Port

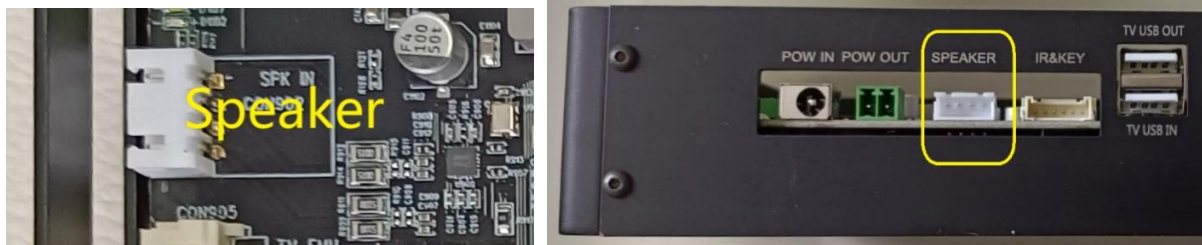

TV Magic Box has a I2S sampling IC for stereo audio sampling from speakers' connector. The connector should connect with TV mainboard's Speaker out connector. Customized cable is needed since different TV product has different speaker connector type. Connector at TV Magic Box side is common.

2.4 HDMI Ports

2.4.1 HDMI0 Group

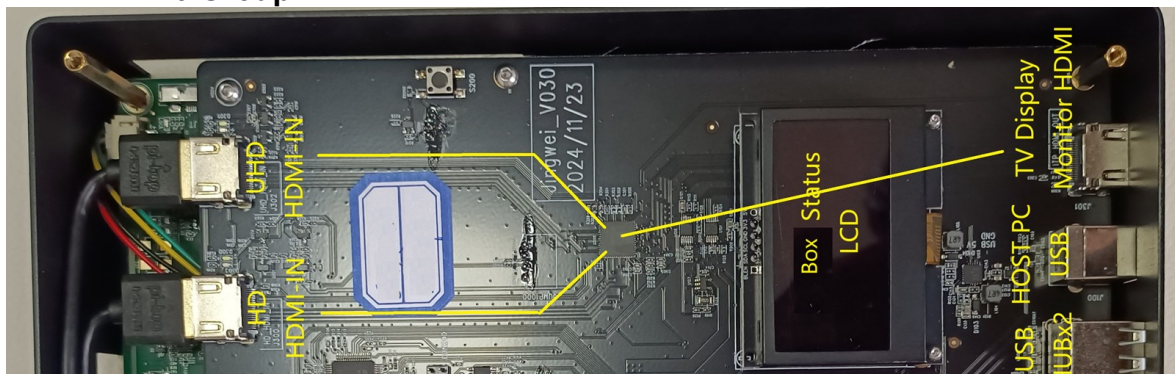

HDMI0 group is for HDMI interface with display adaptor board. It has 2 inputs and one output. The 2 input are mapping to display adaptor board's 2 HDMI output ports **UHD** and **HD**. UHD is for FHD/UHD and above products. HD is only for HD products. Output is Monitor HDMI output, it contains display information from TV mainboard and audio information from speaker.

2.4.2 HDMI1 Group

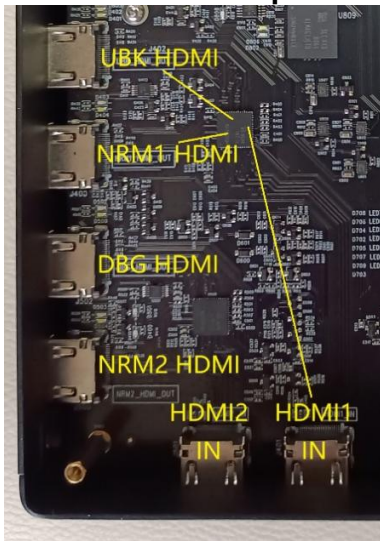

HDMI1 group is for TV HDMI test and SoC level unbrick. It has one input and 2 outputs. It's input **HDMI1 IN** can get HDMI signal from a TV stick and transfer the HDMI signal to **Normal HDMI1** output or **Unbrick HDMI** output. Normal HDMI1 output can act as HDMI port only. Beside HDMI port function, unbrick HDMI output can provide unbrick function for TV mainboard. We realize Amlogic and MTK's SoC level unbrick function in TV Magic Box, the unbrick control signals goes through unbrick HDMI output port.

2.4.3 HDMI2 Group



HDMI2 group is for TV HDMI test and Debug UART. It has one input and 2 outputs. It's input **HDMI2 IN** can get HDMI signal from a TV stick and transfer the HDMI signal to **Normal HDMI2** output or **Debug HDMI** output. Normal HDMI2 output can act as HDMI port only. While Debug HDMI port has debug UART signals as well.

2.5 Host USB & USB HUB

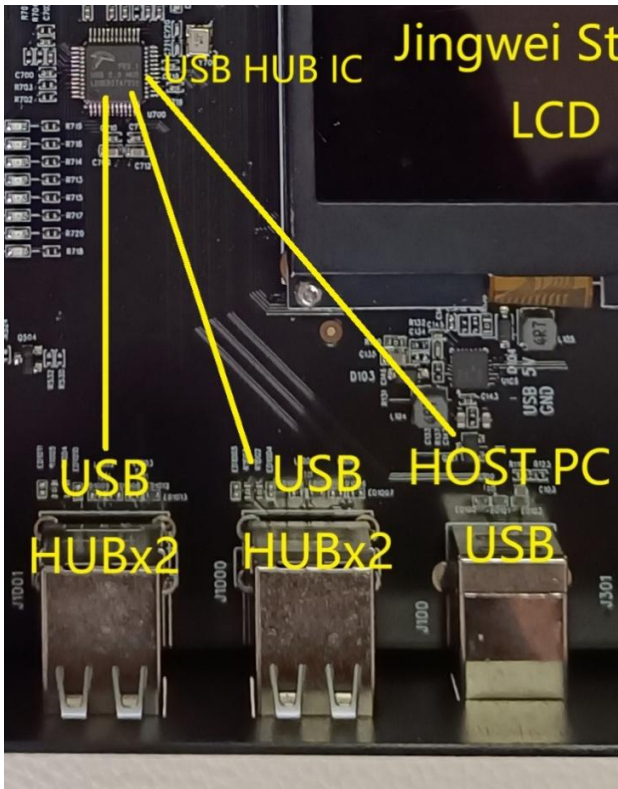

Host(PC) USB is only USB connection with Host PC.

There are four USB HUB ports. Customer can connect their own USB equipment under the 4 USB ports. This helps the host application to find USB devices easily.

2.6 TV USB

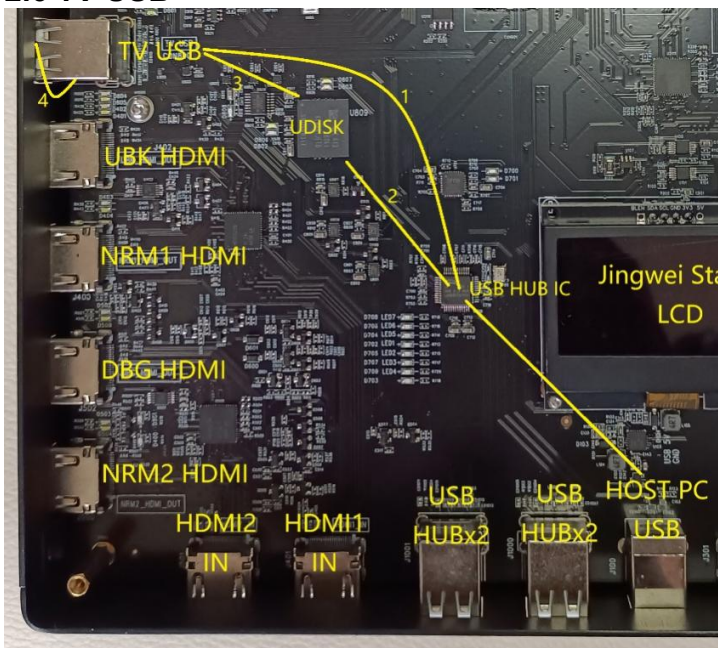

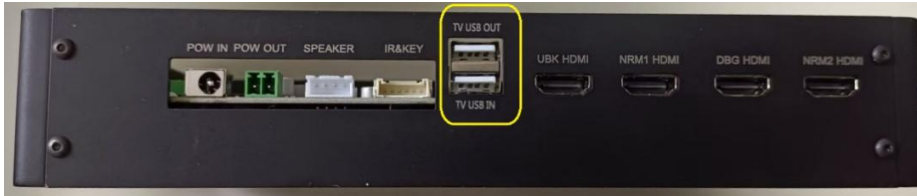

TV USB is the USB port connected with TV. There are four USB paths for TV USB testing. Host to DUT(Host PC use ADB control TV directly, **TV USB IN**), Host to UDisk (Host PC connect to onboard UDisk), DUT to UDisk(TV USB connect to onboard UDisk) and DUT to a TV external accessory (**TV USB OUT**)

2.7 12V power input port

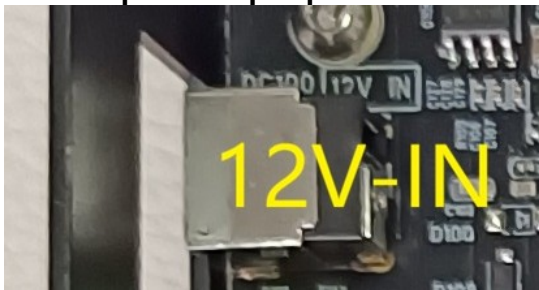

Power adaptor send 12V power through the port to provide power for TV Magic Box/Display Adaptor board and TV mainboard.

2.8 TV power output port





TV Magic Box can provide power to TV main board, the voltage can be configured from 12V to 36V by software. And TV Magic Box can monitor power consumption of TV mainboard at this port.

Chapter 3: HDMI port test / Debug and Unbrick

3.1 HDMI1 Group

HDMI1 has 1 input and 2 outputs. Customer can connect a TV stick with HDMI1 input as a video source. 2 HDMI output are NRM1 HDMI and UBK HDMI. User can use AT commands to switch HDMI1 Group.

HDMI1 Group AT Command			
Command	Return	Behavior	Comments
AT+HDMI1=NRM1	OK	Switch HDMI1 input to NRM1 HDMI output and turn on the output	
AT+HDMI1=UBK	OK REJECT	Switch HDMI1 input to UBK HDMI output and turn on the output	The command will return REJECT if this HDMI port is in Unbrick Mode
AT+HDMI1=OFF	OK	Switch off HDMI output	It can remember HDMI path
AT+HDMI1=ON	OK	Switch on HDMI output	It will turn on HDMI output with the previous HDMI path
AT+HDMI1?	HDMI1:ON,NRM1 HDMI1:OFF,NRM1 HDMI1:ON,UBK HDMI1:OFF,UBK	Check HDMI1 status	Return on/off and HDMI path information
AT+UBKI2C=ON	OK	Switch UBK HDMI to Amlogic Unbrick mode	In this mode UBK HDMI is act as Amlogic Unbrick dongle
AT+UBKI2C=OFF	OK	Switch UBK HDMI to HDMI	HDMI mode is for

		mode	normal HDMI test same as NRM1 HDMI
AT+UBKI2C?	UBKI2C:ON UBKI2C:OFF	Check UBK HDMI mode	Amlogic unbrick mode or Normal HDMI mode on UBK HDMI

3.2 HDMI2 Group

HDMI2 has 1 input and 2 outputs. Customer can connect a TV stick with HDMI2 input as a video source. 2 HDMI output are NRM2 HDMI and DBG HDMI. User can use AT commands to switch HDMI2 Group.

HDMI2 Group AT Command			
Command	Return	Behavior	Comments
AT+HDMI2=NRM2	OK	Switch HDMI2 input to NRM2 HDMI output and turn on the output	
AT+HDMI2=DBG	OK REJECT	Switch HDMI2 input to DBG HDMI output and turn on the output	The command will return REJECT if this HDMI port is in Unbrick Mode
AT+HDMI2=OFF	OK	Switch off HDMI output	It can remember HDMI path
AT+HDMI2=ON	OK	Switch on HDMI output	It will turn on HDMI output with the previous HDMI path
AT+HDMI2?	HDMI2:ON,NRM2 HDMI2:OFF,NRM2 HDMI2:ON,DBG HDMI2:OFF,DBG	Check HDMI2 status	Return on/off and HDMI path information
AT+DBGUART=ON	OK	Switch DBG HDMI to debug UART mode	In this mode HDMI UART is enabled
AT+DBGUART=OFF	OK REJECT	Switch off DBG HDMI debug UART mode	HDMI UART is disabled (Case6 will return REJECT , DBGUART always on)
AT+DBGUART?	DBGUART:ON DBGUART:OFF	Check DBG HDMI mode	DBG UART mode or Normal HDMI mode on DBG HDMI
AT+DBGCASE=X	OK	Setup Debug UART config details. Each case will map to UART through which pin , how to enable , etc. refer to 1.2.1 TV debug	Valid value: 2, 3, 4, 5, 6 (Config tool only)

		port support	
AT+DBGCASE?	DBGCASE:2 DBGCASE:3 DBGCASE:4 DBGCASE:5 DBGCASE:6	Return DBG HDMI UART config number	

Chapter 4: TV USB port test and extension test features for TV test

4.1 USB Switch

For TV USB test. TV Magic Box uses 4 USB switcher to enable one of 4 USB paths at one time. The

4 USB paths are Host to DUT(Host PC use ADB control TV directly, **TV USB IN**), Host to UDisk (Host PC connect to onboard UDisk), DUT to UDisk(TV USB connect to onboard UDisk) and DUT to a TV external accessory (**TV USB OUT**)

4.2 Onboard UDisk

An onboard USB Disk is integrated in TV Magic Box. It can be used to test TV USB and realize some extension features.

TV USB Test AT Commands			
Command	Return	Behavior	Comments
AT+USBPATH=HST2DUT	OK	Host USB connect with DUT	
AT+USBPATH=HST2DSK	OK	Host USB connect with UDisk	
AT+USBPATH=DUT2DSK	OK	DUT connect with UDisk	
AT+USBPATH=HST#DUT	OK	Host USB connect with DUT w/o VBUS	
AT+USBPATH=DUT2EXT	OK	DUT IN loop to DUT OUT	v2 New
AT+USBPATH=OFF	OK	All USB Path OFF	It can remember USB path
AT+USBPATH=ON	OK	Switch on USB Path	It will turn on previous USB path
AT+USBPATH?	USBPATH:ON,HST2DUT USBPATH:OFF,HST2DUT USBPATH:ON,HST2DSK USBPATH:OFF,HST2DSK USBPATH:ON,DUT2DSK USBPATH:OFF,DUT2DSK USBPATH:ON,HST#DUT USBPATH:OFF,HST#DUT	Check USB status	Return on/off and USB path information

	USBPATH:ON,DUT2EXT		
	USBPATH:OFF,DUT2EXT		

Chapter 5: IR/Key Emulation and LED monitor

IR/Key Emulation and LED monitor Command			
Command	Return	Behavior	Comments
AT+KEY_DAC=0xXXXX	OK	Set TV hard key Analog value	Valid from 0x0000 to 0x0FFF Power Key is 0x0000 No Key is 0x0FFF
AT+HD_KEY=KEYPWR (Other keys → TBD)	OK	Short press power key	press pulse width is 300ms
AT+IRCSM=<Value>	OK	Set IR customer code	exp: AT+IRCSM=0x3789
AT+IRCSM?	IRCSM:0x3789	Get IR customer code	
AT+DUT=<value>	OK		value is PCBA or TV PCBA will send enveloped IR code TV will send out real IR code with 38K carrier
AT+DUT?	DUT:PCBA (or TV)		
AT+IR_NEC=0xXX	OK	Send IR code (customer code+key code)	Fixed DEMO customer code
AT+HD_NEC=NECPWR (Other IR code, NECHOM, NECSEL, NECLFT, NECRIT, NECUP, NECDWN, NECPUP, NECPDN, NECVUP, NECVDN, NECMNU, NECMUT,NECBAK)	OK	Default send DEMO IR code	Default use DEMO customer code
AT+IR_RC5=0xXX	OK	Send DEMO RC5 code	
AT+TVLED?	TVLED:XXX (RGB value)	Return TV LED status	Most TV only has Red LED Some TV has Blue LED as well Green LED is reserved

Chapter 6: Display Adaptor Board Configuration/Control and Video/Audio combination

Display Adaptor Board Command			
Command	Return	Behavior	Comments
AT+HDMI0=UHD	OK	Switch to Display Board UHD HDMI①	
AT+HDMI0=HD	OK	Switch to Display Board HD HDMI②	
AT+HDMI0=OFF	OK	Switch off HDMI output	It can remember HDMI path
AT+HDMI0=ON	OK	Switch on HDMI output	It will turn on HDMI output with the previous HDMI path
AT+HDMI0?	HDMI0:ON, UHD HDMI0:OFF, HD HDMI0:ON, UHD HDMI0:OFF,UHD	Check HDMI0 status	Return on/off and HDMI path information
AT+BOHOOACT=PATT1	OK	White Pattern	SW New
AT+BOHOOACT=PATT2	OK	8 Step Color Pattern	SW New
AT+BOHOOACT=PATT3	OK	Color Block Pattern	SW New
AT+BOHOOACT=PATT4	OK	Resume Input	SW New
AT+BOHOOACT=UNPAT	OK	Resume Input	SW New
AT+BOHOOACT=51ON	OK	BOHOO 51 MCU POWER ON	v2 New
AT+BOHOOACT=51OFF	OK	BOHOO 51 MCU POWER OFF	v2 New
AT+BOHOOTYP=X	OK	Setup Display Type	Valid Type (Config Tool Only) : VB1-4K-1DIV VB1-4K-2DIV LVDS-FHD8BIT LVDS-FHD8BIT-SWP LVDS-FHD10BIT

			LVDS-FHD10BIT-SWP LVDS-HD (Protected by VFLG → PRD)
AT+BOHOOTYP?	BOHOOTYP:VB1-4K-1DIV BOHOOTYP:VB1-4K-2DIV BOHOOTYP:VB1-4K-1DIV BOHOOTYP:VB1-4K-2DIV BOHOOTYP:LVDS-FHD8BIT BOHOOTYP:LVDS-FHD8BIT-SWP BOHOOTYP:LVDS-FHD10BIT BOHOOTYP:LVDS-FHD10BIT-SWP BOHOOTYP:LVDS-HD	Check Display Type	If PRD VFLG not been set. It will return default value → VB1-4K-1DIV
AT+PNL_VCC?	PNL_VCC:HIGH / LOW		v2 New
INDICATOR:PNL_PWRCUT			v2 New
INDICATOR:PNL_PWRUP			v2 New

- ① Must switch to right Display channel , UHD is mapping to 51pin FHD LVDS and 51 pin UHD VB1 . BOHOO commands are needed with this HDMI channel;
- ② Must switch to right Display channel , HD is mapping to rear HD LVDS , with this HDMI channel , do not need BOHOO commands ;

Chapter 7: TV mainboard power switch and monitor

TV Magic Box can provide power to TV mainboard (Voltage can be configured from 12V to 36V). It can switch on/off the power and monitor power consumption.

TV mainboard power switch and monitor AT Command			
Command	Return	Behavior	Comments
AT+PCBA_12V=ON	OK	Turn on mainboard power	
AT+PCBA_12V=OFF	OK	Turn off mainboard power	
AT+PCBA_12V?	PCBA_12V:ON	Monitor	

	PCBA_12V:OFF	mainboard power status	
AT+PCBA_PWR=ON	OK	Enable Bump up DCDC	v2 New
AT+PCBA_PWR=OFF	OK	Disable Bump up DCDC	v2 New
AT+PCBA_PWR?	PCBA_PWR:ON PCBA_PWR:OFF	Monitor Bump up DCDC status	v2 New
AT+PCBA_VOT=12V(18V,24V)	OK	Set PCBA Power Voltage	v2 New
AT+PCBA_VOT?	PCBA_VOT:12V	Get PCBA Power Voltage	v2 New
AT+PCBAPOW?	PCBAPOW:12.332V , 0.475A	Monitor mainboard power consumption	

Chapter 8: TV Magic Box status monitor

8.1 LCD



3.5 inch 128*64 LCD used to show product config and working state information etc.

8.2 Front panel Green LED



The LED indicates TV Magic Box power is good.

8.3 Front panel 2 Color LED



The 2 LEDs are controlled by TV mainboard. It shows TV's working states (normal , STR etc)

8.4 Front panel 3 Color LED



The 3 Color LED controlled by TV Magic Box's MCU. It shows TV Magic Box's status.

8.5 Front panel Button



Push the button can switch LCD display screen to show status in different categories.

8.6 Side LEDs of HDMI ports

There is one white LED and one blue LED beside each HDMI port. White LED shows HDMI port power is good. Blue LED shows HDMI port data is working. Once you enable one HDMI path , the 2 LED beside it will be lighted on.

8.7 Side LEDs of TV USB switchers

There are four sets of white LED and blue LED near TV USB to indicate on/off of each USB path. Each set of white and blue LEDs shows a USB path is on or off.

Chapter 9: TV Magic Box Host Tools

9.1 Downloading tool

The Downloading tool is used to upgrade TV Magic Box firmware.

9.2 Configuration tool

The Configuration tool is used to config TV Magic Box before using.

9.3 Engineering tool

The Engineering tool helps you run tests manually.

Chapter 10: System AT Command

10.1 Common System SW Command

Common System AT Command			
Command	Return	Behavior	Comments
AT?	OK	Basic AT command	
AT+PING?	PING:JNWE	Basic Ping command	
AT+VER?	VER:00.00.18	Return Version	
AT+SETVFLG=XXX	OK	Set lock flags for system values	Config Tool Only Valid Values: DSN PRD NVM USR ALL
AT+DELVFLG=XXX	OK	Unlock flags for system values	Config Tool Only Valid Values: DSN PRD NVM USR ALL
AT+NVMVER=1	OK	Set NVM version	Config Tool Only Protected by NVM VFLG
AT+NVMVER?	NVMVER:0x1	Return NVM version	

AT+DSN=	OK	Set DSN (Device Serial Number)	Config Tool Only Protected by DSN VFLG
AT+DSN?	DSN:JNWE-0-0000-0000	Return Device Serial Number	
AT+OWNER=	OK	Set Owner Name	Config Tool Only Protected by USR VFLG
AT+OWNER?	OWNER:TideYin	Return Owner Name	
AT+LOGIN=	OK	Set Login	Config Tool Only Protected by USR VFLG
AT+LOGIN?	LOGIN:tideyin@	Return Login	
AT+LOCAT=	OK	Set Location	Config Tool Only Protected by USR VFLG
AT+LOCAT?	LOCAT:PEK12	Return Location	

10.2 Specific SW Command

TV Magic Box Specific AT Command			
Command	Return	Behavior	Comments
AT+PRODUCT=	OK	Set TV product name	Config Tool Only Protected by PRD VFLG
AT+PRODUCT?	PRODUCT:Anna	Return TV product name	
AT+DBGCASE=X	OK	Set Debug Case	Config Tool Only, Protected by PRD VFLG Valid value: 2, 3, 4, 5, 6
AT+DBGCASE?	CASE:2 (2,3,4,5,6)	Return Debug Case	
AT+UBKCASE=X	OK	Set unbrick Case	Config Tool only Protected by PRD VFLG For Amlogic SoC level unbrick. Valid value: USB , SD
AT+UBKCASE?	UBKCASE:USB	Return unbrick Case	
AT+BOHOOTYP=X	OK	Set Display type	Config Tool only Protected by PRD VFLG Valid value: VB1-4K-1DIV

			VB1-4K-2DIV LVDS-FHD8BIT LVDS-FHD8BIT-SWP LVDS-FHD10BIT LVDS-FHD10BIT-SWP LVDS-HD
AT+BOHOOTYP?	BOHOOTYP:VB1-4K-1DIV	Return Display type	
AT+DUTDSN=X	OK		Exp: =G9V3K0003387006N
AT+DUTDSN?	DUTDSN:G9V3K0003387006N	Return DUT's DSN	

10.3 Common System HW Command

Common System AT Command			
Command	Return	Behavior	Comments
AT+SYSRST=REBOOT	OK	System Reboot	
AT+SYSRST=DFU	OK	System reboot to DFU download mode	
AT+RGB=011	OK	Set RGB LED	
AT+SYSCMD=LCDOFF	OK	Turn off LCD	
AT+SYSCMD=LCDLOGO	OK	LCD show LOGO	